

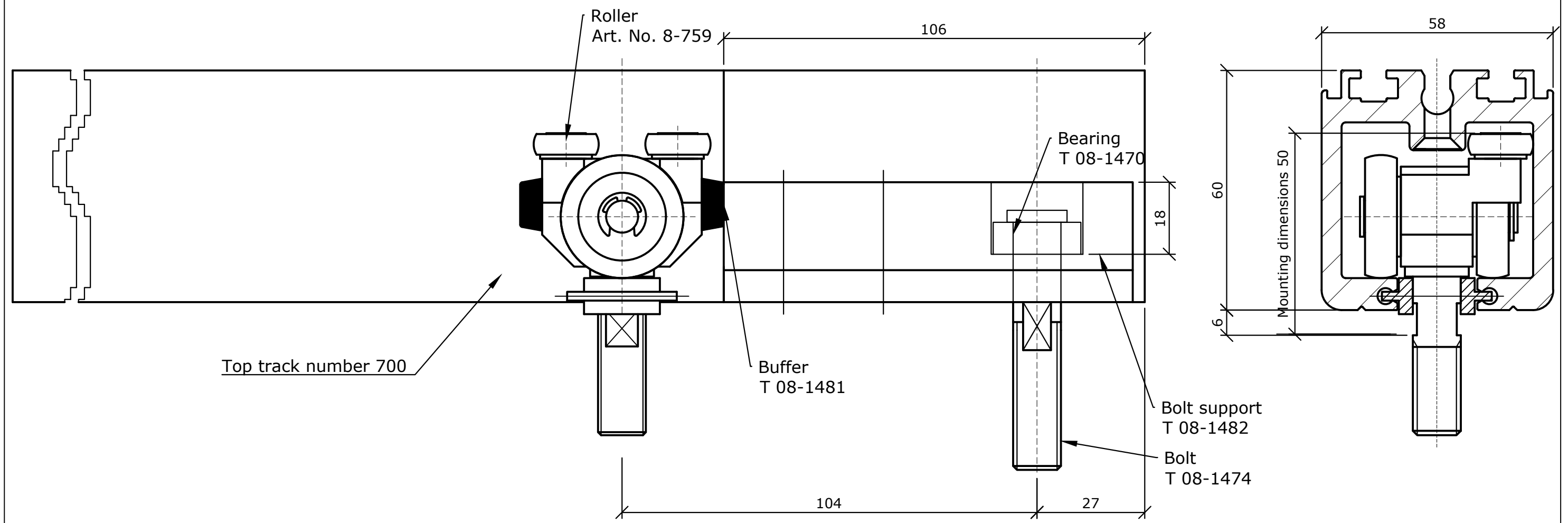

View from the outside
 (applies to Type 2 and Type 2 RA RE + Type 3 and Type 3 RA RE)



	DEKO Tlf./Tel: +45 43 55 77 11 www.deko.dk / www.deko.com	Projekt/Project: DEKO	
	Sags Nr./Case No.: 2017-05-30	Emne/Subject: DEKO PV Type 2 and 3 RE + RA	Dato/Date: 2017-05-30
Mål/Scale: 1:1		Revideret/Revision: 2017-06-06-V01	Signatur Signature